

Performance Transmission Cooler GM Allison 2006-2010

(124062000)

Installation Guide

DISCLAIMER OF LIABILITY

Performance products can increase horsepower above and beyond factory specifications. Additional horsepower creates more stress on the drive-train components, which could result in drive-train failure.

Note regarding emissions-related, non-E.O.-legal products: THESE PRODUCTS ARE LEGAL IN CALIFORNIA ONLY FOR RACING VEHICLES THAT MAY NEVER BE USED, OR REGISTERED OR LICENSED FOR HIGHWAY OR OFF-ROAD USE.

This agreement sets forth the terms and conditions for the use of PPE products. The installation of this product indicates that the Buyer has read and understands this agreement and accepts the terms and conditions. PPE (Pacific Performance Engineering) Inc., its distributors, employees, and dealers (the "Seller") shall not be responsible for the product's proper use and service. The buyer hereby waives all liability claims. The Buyer hereby acknowledges no reliance on the Seller's skill or judgment to select or furnish goods suitable for any particular purpose and that there are no liabilities which extend beyond the description on the face hereof, and the Buyer hereby waives all remedies or liabilities expressed or implied, arising by law or otherwise (including without any obligation of the Seller with respect to fitness, merchantability and consequential damages), or whether or not occasioned by the Seller's negligence. The Seller disclaims any warranty and expressly disclaims any liability for personal injury or damages. The Buyer acknowledges and agrees that the disclaimer of any liability for personal injury is a material term for this agreement and the Buyer agrees to indemnify the Seller and to hold the Seller harmless from any claim related to the item of equipment purchased. Under no circumstances will the Seller be liable for any damages or expenses by reason of use or sale of any such equipment. The Seller assumes no liability regarding the improper installation or misapplication of its products. It is the installer's responsibility to check for proper installation and if in doubt, contact the manufacturer. The Buyer is solely responsible for all warranty issues from the manufacturer.

LIMITATION OF WARRANTY

The Seller gives Limited Warranty as to description, quality, merchantability, and fitness for a particular purpose, productiveness, or any other matter of Seller's product sold herewith. The Seller shall not be responsible for the products proper use and service and the Buyer hereby waives all rights other than those expressly written herein. This warranty shall not be extended, altered or varied except by a written instrument signed by Seller and Buyer. The Warranty on PPE Manifolds and Up-Pipes Kits, OEM-Length Up-Pipes is three (3) years, a limited lifetime warranty on PPE cast aluminum pans and covers, and a limited lifetime warranty on PPE Transmission Coolers and one (1) year limited warranty on all other PPE products from the date of sale to original buyer and limited solely to the parts contained within the products kit. All products that are in question of Warranty must be returned prepaid to the Seller and must be accompanied by a dated proof of purchase receipt. All Warranty claims are subject to approval by Seller. Under no circumstances will the Seller be liable for any labor charged or travel time incurred in diagnosis for defects, removal, or re-installation - of this product or any other contingent expenses. Under no circumstances will the Seller be liable for any damage or expenses incurred by reason of the use or sale of any such equipment. In the event that the buyer does not agree with this agreement: the buyer may promptly return this product, in a new and unused condition in its original packaging, with a dated proof of purchase to the place of purchase within ten (10) days from date of purchase for a full refund. The installation of this product indicates that the buyer has read and understands this agreement and accepts its terms and conditions.

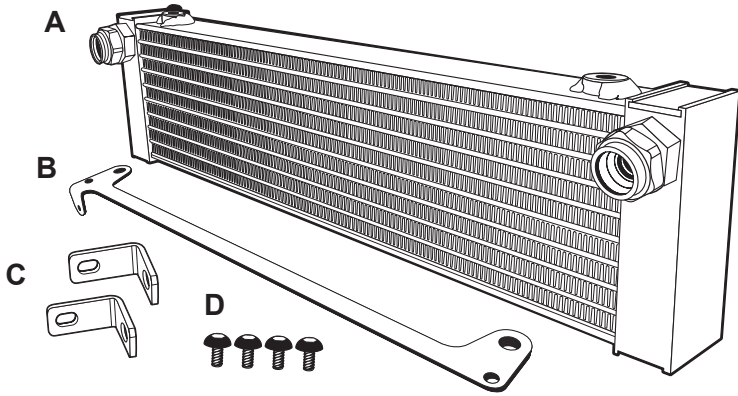
CONTENTS:

- 1 (A) Cooler
- 1 (B) Bottom Bracket
- 2 (C) Top Brackets
- 4 (D) Allen Button Head Bolts

TOOLS NEEDED:

- 1/4" or 3/8" ratchet
- 6" to 8" extension
- 10mm socket
- 7/16" socket and 7/16" combination wrench
- Flathead screwdriver (in some cases)

BEFORE BEGINNING:

Make sure vehicle is cool.

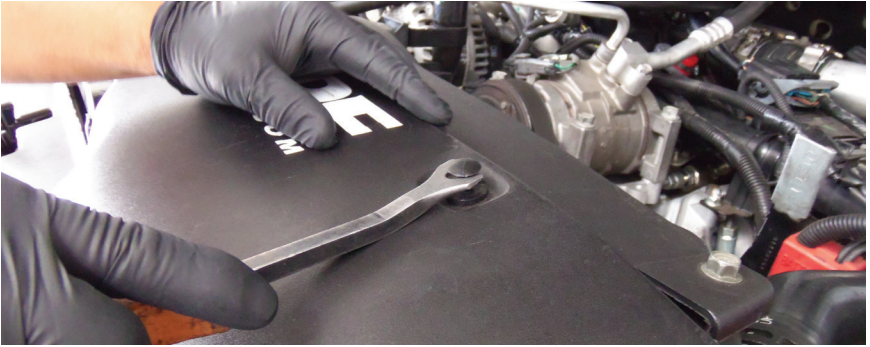
**STEP 1**

Remove retaining clips and radiator cover.

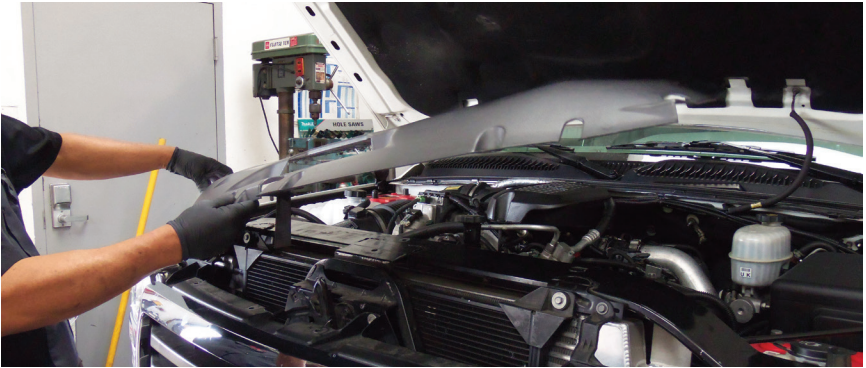
**STEP 2**

Remove radiator cover.

**STEP 3**

Remove the front grill bolts.

**STEP 4**

Pull grill clips.

**STEP 5**

Pull grill forward to detach from clip.

**STEP 6**

Remove the retaining clips and oil lines. Place towels or collection container below fitting to catch fluid.

**STEP 7**

Pull out oil lines.

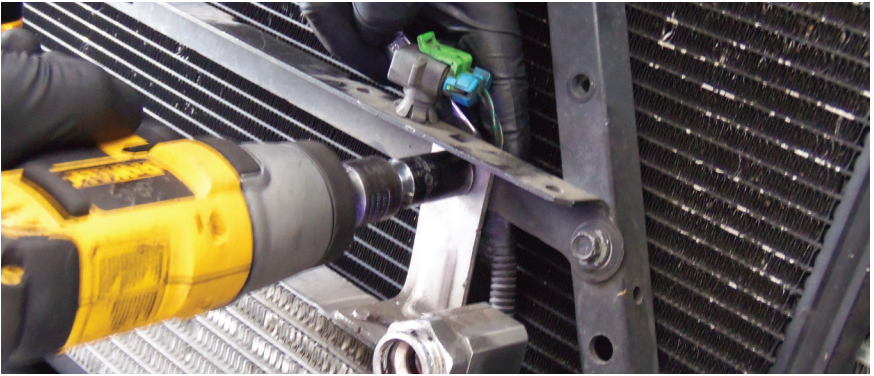

STEP 8

Remove bracket bolts and stock cooler.

NOTE: First year LMM 2007.5 models require modification to the Trans Cooler Bracket. Trim approximately 3/4 inch to allow the larger PPE Trans Cooler to fit. De-burr edge to finish.

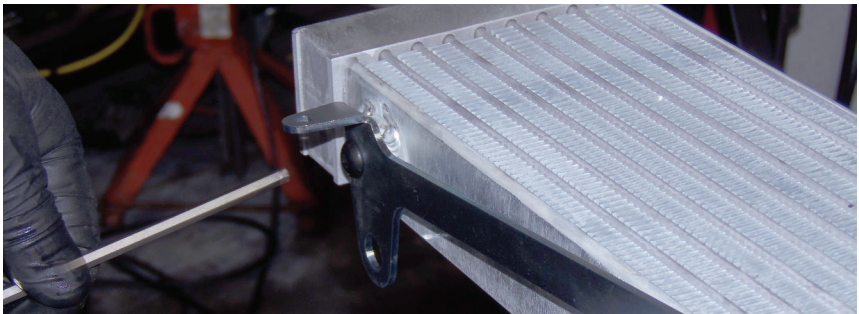
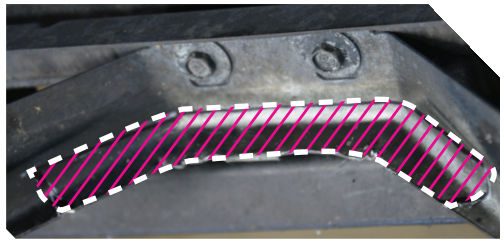

STEP 9

Install lower bracket and hardware.

NOTE: The brackets are shipped installed but need to be re-installed as shown to fit properly.

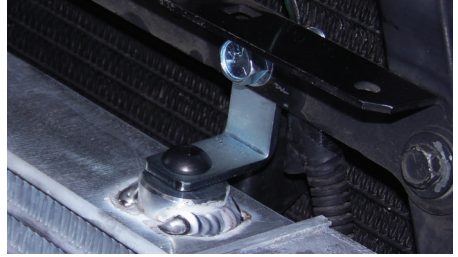
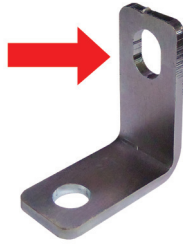
**STEP 10**

(A) Install cooler bracket bolts. Be sure to place the bracket with the oval hole at the top and the round one at the bottom.

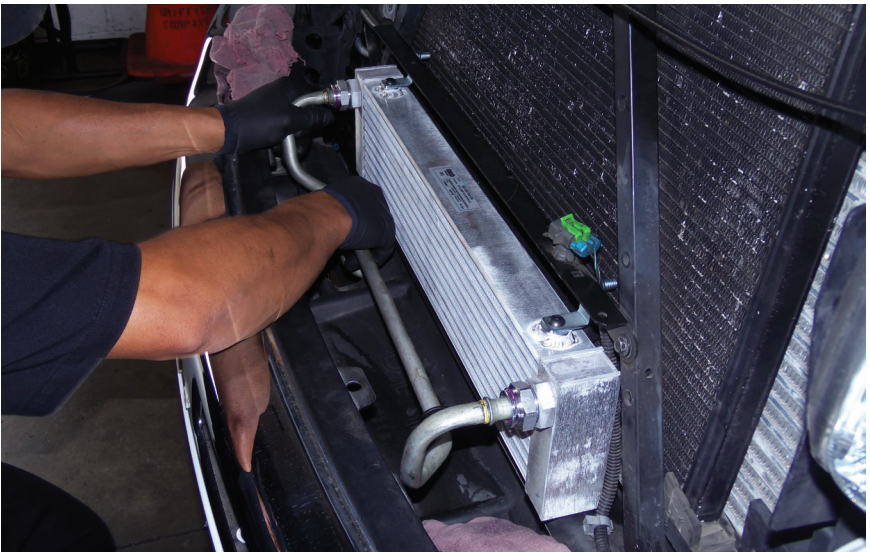

(B) Locate lower bracket and install fastener in the same position as previously installed factory cooler. Tighten fasteners to secure.

**STEP 11**

Install cooler lines and retainer clips.

**STEP 12**

Slide the clip holder into position.

**STEP 13**

Be sure to secure cooler lines into the plastic holder. Fill and check fluid level. Check for leaks. Reinstall front grill. Start engine. Check for leaks.



5011 Brooks St. Montclair CA 91763

*PPEdiesel.com
sales@ppediesel.com
Phone: (714) 985-4825*