

# **Crankcase Breather Filter Kit - GM 6.6L Duramax 2007.5-2010 LMM**

(114027500)

## ***Installation Guide***



Performance products can increase horsepower above and beyond factory specifications. Additional horsepower creates more stress on the drive-train components, which could result in drive-train failure.

Note regarding emissions-related, non-E.O.-legal products: THESE PRODUCTS ARE LEGAL IN CALIFORNIA ONLY FOR RACING VEHICLES THAT MAY NEVER BE USED, OR REGISTERED OR LICENSED FOR HIGHWAY OR OFF-ROAD USE.

This agreement sets forth the terms and conditions for the use of PPE products. The installation of this product indicates that the Buyer has read and understands this agreement and accepts the terms and conditions. PPE (Pacific Performance Engineering) Inc., its distributors, employees, and dealers (the "Seller") shall not be responsible for the product's proper use and service. The buyer hereby waives all liability claims. The Buyer hereby acknowledges no reliance on the Seller's skill or judgment to select or furnish goods suitable for any particular purpose and that there are no liabilities which extend beyond the description on the face hereof, and the Buyer hereby waives all remedies or liabilities expressed or implied, arising by law or otherwise (including without any obligation of the Seller with respect to fitness, merchantability and consequential damages), or whether or not occasioned by the Seller's negligence. The Seller disclaims any warranty and expressly disclaims any liability for personal injury or damages. The Buyer acknowledges and agrees that the disclaimer of any liability for personal injury is a material term for this agreement and the Buyer agrees to indemnify the Seller and to hold the Seller harmless from any claim related to the item of equipment purchased. Under no circumstances will the Seller be liable for any damages or expenses by reason of use or sale of any such equipment. The Seller assumes no liability regarding the improper installation or misapplication of its products. It is the installer's responsibility to check for proper installation and if in doubt, contact the manufacturer. The Buyer is solely responsible for all warranty issues from the manufacturer.

### **LIMITATION OF WARRANTY**

The Seller gives Limited Warranty as to description, quality, merchantability, and fitness for a particular purpose, productiveness, or any other matter of Seller's product sold herewith. The Seller shall not be responsible for the products proper use and service and the Buyer hereby waives all rights other than those expressly written herein. This warranty shall not be extended, altered or varied except by a written instrument signed by Seller and Buyer. The Warranty on PPE Manifolds and Up-Pipes Kits, OEM-Length Up-Pipes is three (3) years, a limited lifetime warranty on PPE cast aluminum pans and covers, and a limited lifetime warranty on PPE Transmission Coolers and one (1) year limited warranty on all other PPE products from the date of sale to original buyer and limited solely to the parts contained within the products kit. All products that are in question of Warranty must be returned prepaid to the Seller and must be accompanied by a dated proof of purchase receipt. All Warranty claims are subject to approval by Seller. Under no circumstances will the Seller be liable for any labor charged or travel time incurred in diagnosis for defects, removal, or re-installation - of this product or any other contingent expenses. Under no circumstances will the Seller be liable for any damage or expenses incurred by reason of the use or sale of any such equipment. In the event that the buyer does not agree with this agreement: the buyer may promptly return this product, in a new and unused condition in its original packaging, with a dated proof of purchase to the place of purchase within ten (10) days from date of purchase for a full refund. The installation of this product indicates that the buyer has read and understands this agreement and accepts its terms and conditions.

# Contents:



- 1 - (1) 17.5" x 5/8" Oil Hose
- 2 - (1) 7" x 5/8" Oil Hose
- 3 - (1) 24" x 1/2" Oil Hose
- 4 - (1) 13" x 1" Oil Hose
- 5 - (1) 35" x 1" Oil Hose
- 6 - (1) 22" x 1" Oil Hose
- 7 - (2) Bolts – 8m x 25mm  
(2) M8 nyloc lock Nuts  
(4) 5/16" grade 8 W
- 8 - (2) M6 x 15mm bolts/Nylock Nuts

- 9 - (6) 1" Hose Clamps
- 10 - (1) Breather Filter
- 11 - (1) T-fitting
- 12 - (2) 1/2" Hose Clamps
- 13 - (4) 27mm/13 Hose Clamps
- 14 - (2) Crankcase Breather Fittings
- 15 - (1) Mounting Bracket (shape may vary)
- 16 - (1) Connector Tube
- 17 - (1) 6" Heat Shield for 5/8" Hose

**Installation:**     **NOTE: Engine should be cool before beginning**

**STEP 1**

Loosen lower hose clamp and Remove Airbox Resonator.

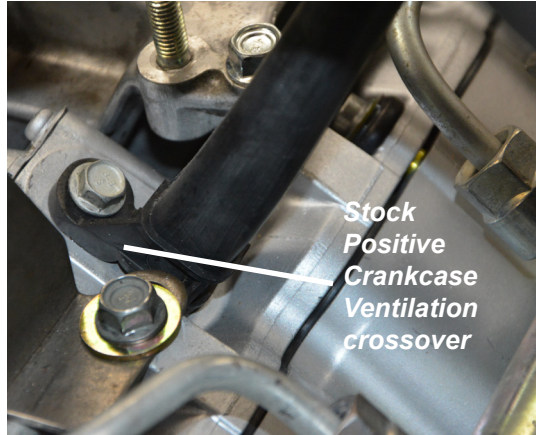

**STEP 2**

Using 10mm socket with long extension and wrench, remove the stock Positive Crankcase Ventilation crossover tube from each side of the heads. Then remove the OEM clamp connecting the PCV crossover tube to the turbo inlet.



Assemble as shown.

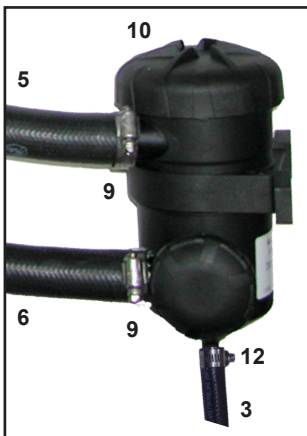
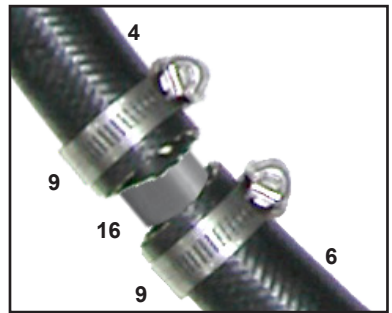
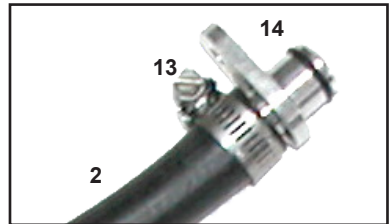
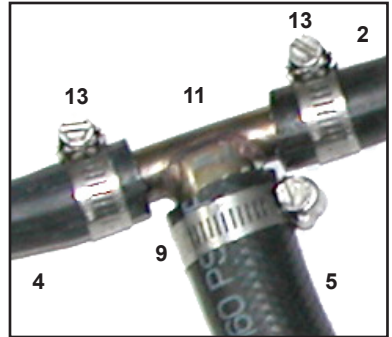
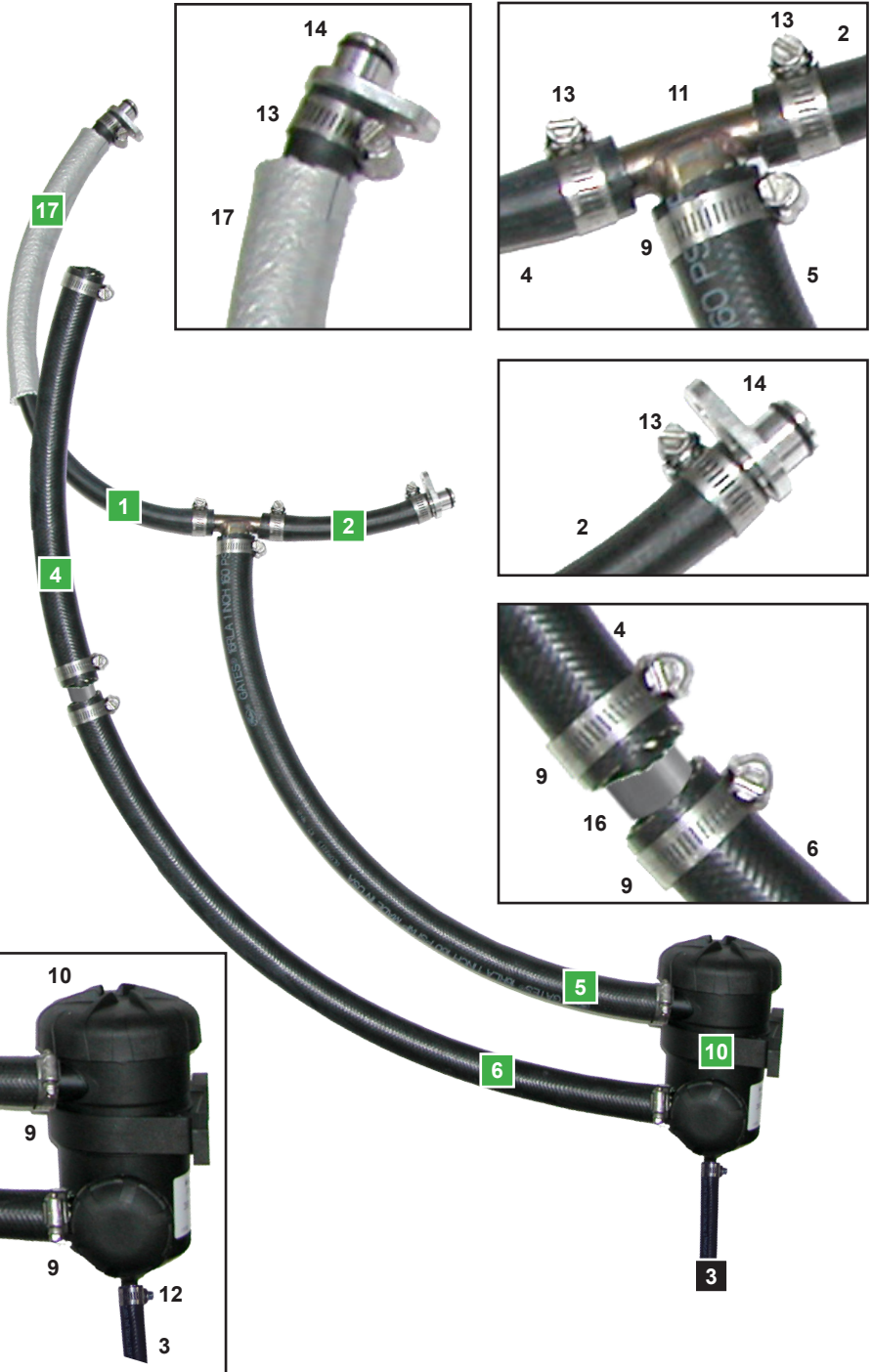

**STEP 3**

*Assemble the 5/8" hose and billet breather adaptors to the stainless steel 1" adaptor supplied with the kit.*

**STEP 4 A/B**

*Install the assembled breather lines in the original PCV valve holes, use silicone lube or grease to lubricate the O-rings on the billet adaptors.*

**STEP 5**

*Tighten down with OEM bolts to 9 (ft-lbs).*

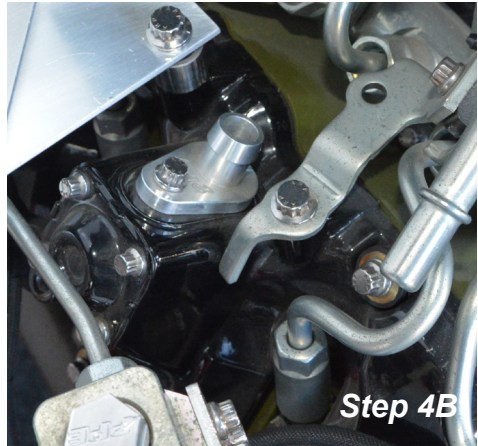
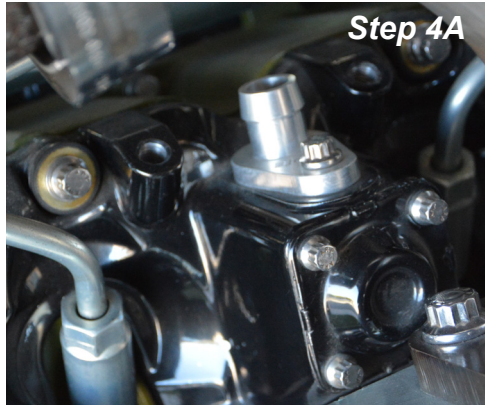



**STEP 6**

*Bolt breather to breather bracket using supplied hardware.*

**STEP 7**

*Remove OEM bolt.*

**STEP 8**

*Mount filter on vehicle with supplied hardware.*

**STEP 9**

*Connect 1" hose from PCV lines to inlet of filter.*

**STEP 10**

*Connect 1" hose from discharge of filter to turbo inlet.*



*Shown installed.*



*5011 Brooks St. Montclair CA 91763*

*PPEdiesel.com  
sales@ppediesel.com  
Phone: (714) 985-4825*