

## Cognito 2-Inch Economy Leveling Lift Kit for 2019+ GM 1500 2WD/4WD Trucks

**INSTALL INSTRUCTIONS:**

Cognito 2-Inch Economy Leveling Lift Kit for 2019+ GM 1500  
2WD/4WD Trucks  
SKU: 110-90795

**PARTS LIST FOR SKU: 110-90795**

QTY	PART #	DESCRIPTION
2	6518	1" Cast Lift Block
2	6734	2019+ GM 6-Lug Spring Preload Spacer
2	90763	2019+ GM 6-Lug Strut Spacer
1	HP9270	Hardware Pack
4	UB-.625X2.6X10.5	10.5" U-Bolts

**WARNING**

Please read this entire instruction sheet before beginning installation. Proper installation of these components requires a qualified mechanic. Always wear safety glasses when using power tools, and take appropriate precautions when working under a vehicle. If these instructions are not properly followed you may jeopardize your, and your passenger's safety, and severe frame, suspension or tire damage may also result from improper installation.

**PARTS LIST FOR SKU: HP9270**

QTY	PART #	DESCRIPTION
2	HARDWARE-63124	6" Black Cable Tie
1	HARDWARE-0708765	1/2" Vinyl Cushion P-Clamp
6	HARDWARE-M10X1.5-FNUT	M10 x 1.5 Class 10 Zinc Locking Flange Nut

**\*\*\*WARNING: VEHICLES WITH SUPER CRUISE SYSTEM\*\*\***

If your vehicle came equipped with the Super Cruise, hands free driving system, the vehicle should not be modified. The Super Cruise system relies on many sensors that must be calibrated by the manufacturer to ensure proper function and safety. If the vehicle is modified by changing the height or rake of the vehicle these sensors are no longer calibrated. At that point the system will no longer work properly and safety or function of the system cannot be guaranteed.



## INTRODUCTION

Thank you for purchasing the Cognito 2-Inch Economy Leveling Lift Kit. This kit is designed to level your vehicle front to rear while retaining majority of OEM components ensuring the OEM ride quality is not compromised. The Cognito 2 Inch Economy Leveling Lift Kit includes the .75 Inch Strut Spacer Kit, .5 Inch Preload Spacer Kit and 1 inch Block and U-Bolt Kit with all with hardware included.

## REQUIREMENTS

- Cutting of the OEM frame and suspension components is required.
- Spring compressor is required.
- Front-end alignment will be required after completion.
- Installation requires a qualified mechanic.
- Follow the OE specifications when replacing or re-installing OE fasteners, retainers, and hardware specified in the OEM manual.
- Always wear safety glasses when using power tools.
- Proper vehicle lifting equipment is required. Always make sure the vehicle is properly supported and **never work under an unsupported vehicle.**

## TECH NOTES

- **Not Compatible with 2019+ AT4, AT4X, ZR2 or Trail Boss trims, nor the 2019 LD/Limited trims (2014-2018 body style).**
- **Not Compatible with Rear Composite Mono-leaf Springs.**
  - To identify, Composite Mono-leaf springs make use of U-bolts with a rounded top.
  - Steel Multi-leaf springs make use of a U-bolts with a square top.
- Trimming of front bumper trim may be necessary based off tire size.
- This lift kit may only be installed on a truck that has not already been lifted or leveled. You cannot stack leveling kits or shock spacers.
- Read instructions carefully and study the pictures (if included) before attempting installation.
- If this product was purchased as part of a kit each kit, and options to kits, are packaged separately. Therefore installation procedures are covered in separate instructions. Familiarize yourself with each specific set of instructions before beginning.
- Check the parts and hardware packages against the parts list to assure that your kit is complete before starting.

## INSTALLATION

1. Rack the vehicle and lift it off the ground, or if no hoist is available then jack the vehicle off the ground and support properly with jack stands. Remove the tires and set them aside.
  - **NEVER WORK ON AN UNSUPPORTED VEHICLE.**
  
2. Create a unique alignment mark between the frame and each of the four eccentric alignment washers.
  - **NOTE:**  
This is done to track where the bolts are removed from and to get the alignment close during reinstallation.
  
3. Remove the lower control arm bolts.  
The plastic insert in the eccentric washers can be left in place. Keep track of where each bolt was removed from and set them aside for reuse later.

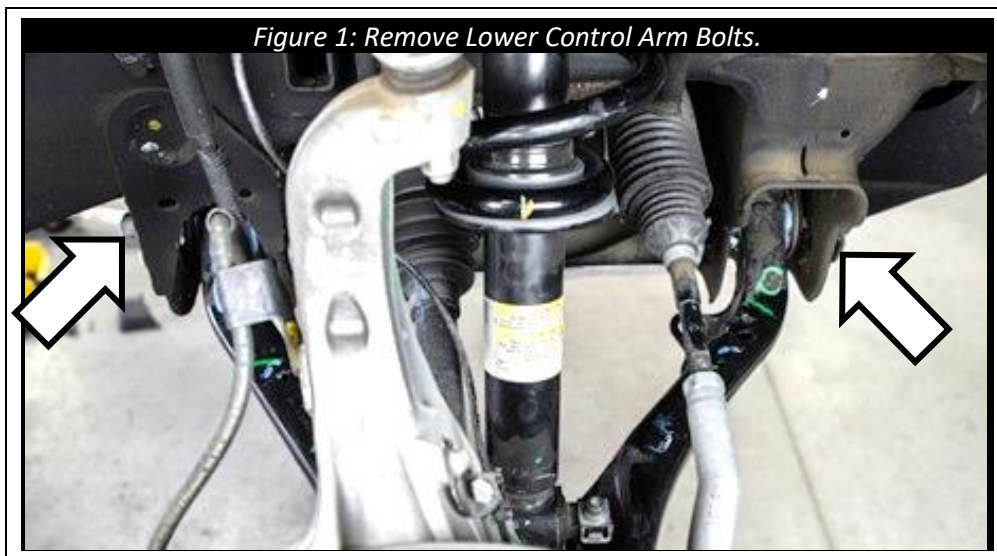

4. Remove the bolts holding the shock to the lower control arm, set the hardware aside to be reused later.

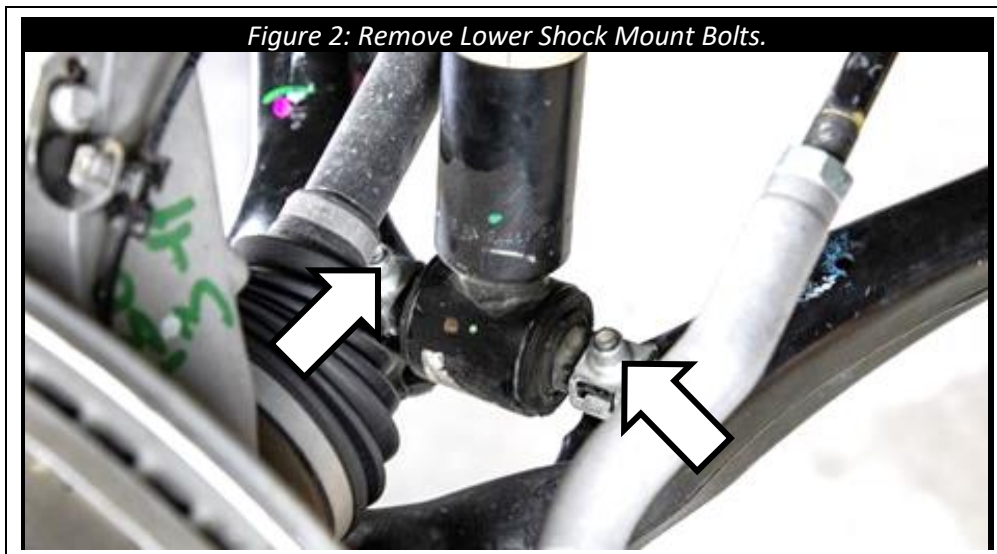

5. Pull the lower control arm out of the frame mount pockets.  
Remove the cross brace from the lower control arm, set it and the mounting hardware to the side.



6. Remove the upper strut mount nuts and remove the OEM struts.

- **NOTE:**

There is a plastic housing that partially blocks access to the passenger side mounting hardware. Lightly prying the housing up will give enough room to remove the outer two nuts. The inner nut can be removed from inside the engine bay.

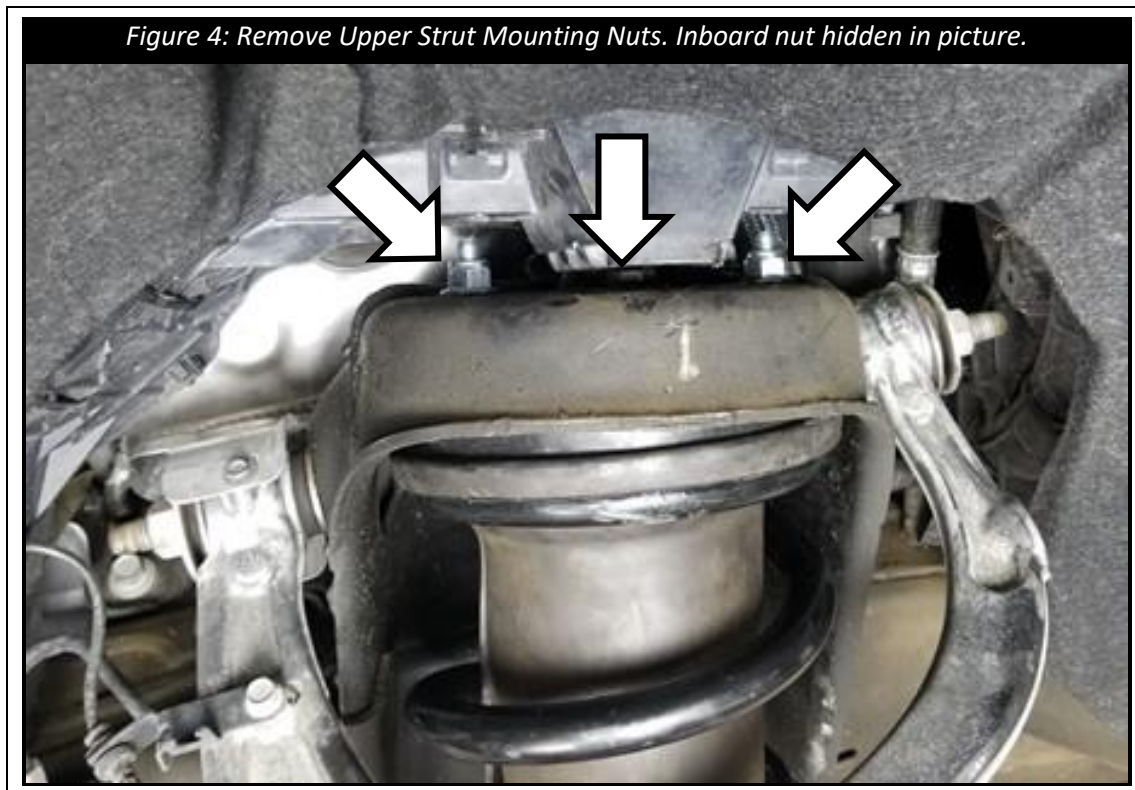

7. Double check length of shock.

Measuring from the top of the strut mount to the dimple in the lower mount pin, a measurement of 22" +/- 1/8" should be obtained.

- **NOTE:**

If a longer or shorter shock is used than what is specified the upper ball joint might bind and break, which could cause an accident and even death.

**Warranty on the product will be voided if the wrong length of shocks are used.**

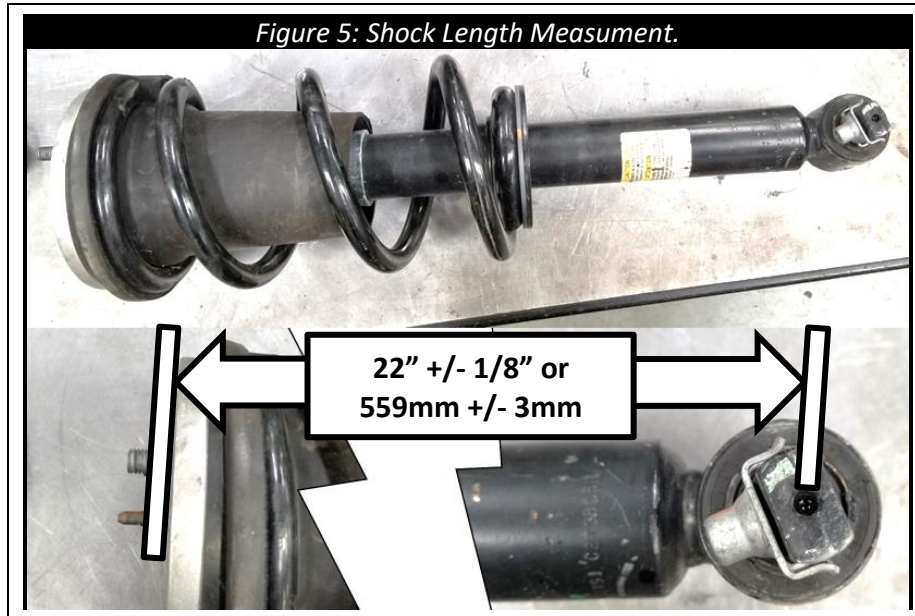

8. Place the strut in a spring compressor.

Locate the lobe on the upper strut mount, create an alignment mark between the lobe and the shock body. Remove the nut in the center of the upper strut mount and remove the shock body from the spring.

- **NOTE:**

**NEVER REMOVE THE NUT IN THE CENTER OF THE UPPER STRUT MOUNT WITHOUT PROPERLY RESTRAINING THE SPRING.** The spring is under load and the center nut is the only retention device holding that load. If the nut is removed without restraining the spring, the spring will rapidly decompress, shooting the upper mount and itself out of position at high velocity and with lethal force.

If the shock shaft is spinning when trying to remove the center nut, loosen the spring compressor a bit or hold the flats on top to the shock shaft with a wrench.

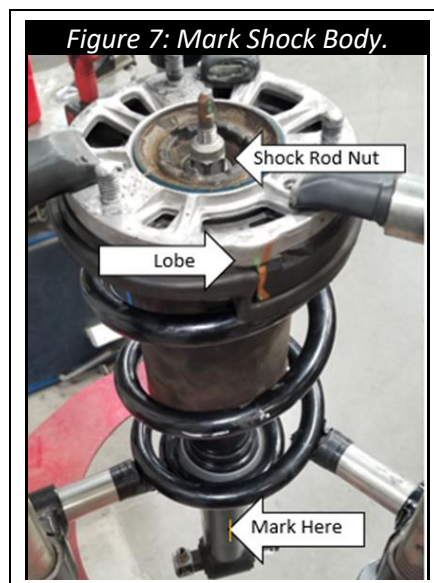

- With the shock body separated from the spring, remove the foam bump stop and plastic spring seat cover. Set them aside for now, they will be reused.

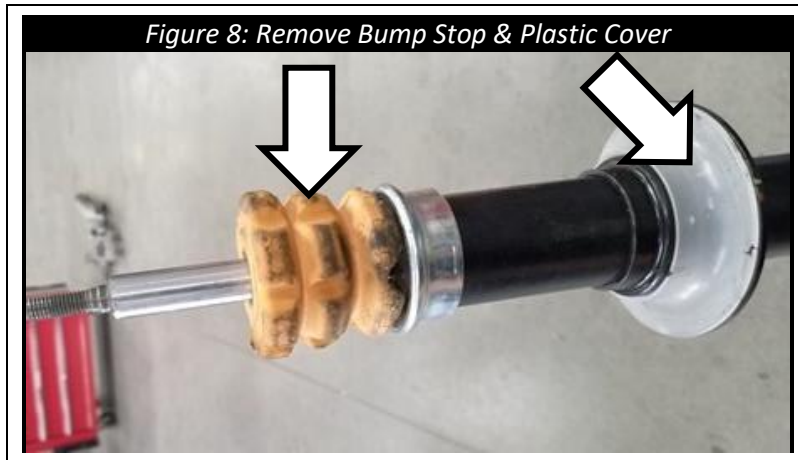

- Locate 1x **6734**, spring preload spacer.

Install the preload spacer on the shock, ensure the large chamfer is facing down and is against the spring seat. Reinstall the plastic cover and bump stop removed earlier.

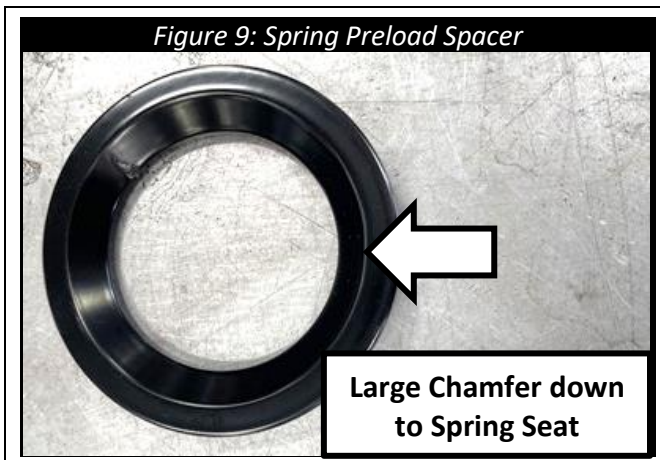

- Reinstall the shock body into the spring, rotate the shock body so that the alignment marks made between the shock body and the lobe of the upper strut mount are now on opposite sides of each other or 180 degrees from its original position.

Install the center nut and torque to **35 ft-lbs.**

- NOTE:**

The spring may need to be compressed further, due to the addition of the preload spacer, to install the center nut.



- 12.** Locate the 6x M10 nuts in **HP9270**.  
Install one nut on each stud of the strut's upper mount and thread them all the way down the stud.
- 13.** Mark each stud 3/4" up from the top of the upper strut mount.  
Cut each stud at the mark made and chamfer the edges.  
Remove the nuts installed on the studs and set them aside for reuse.

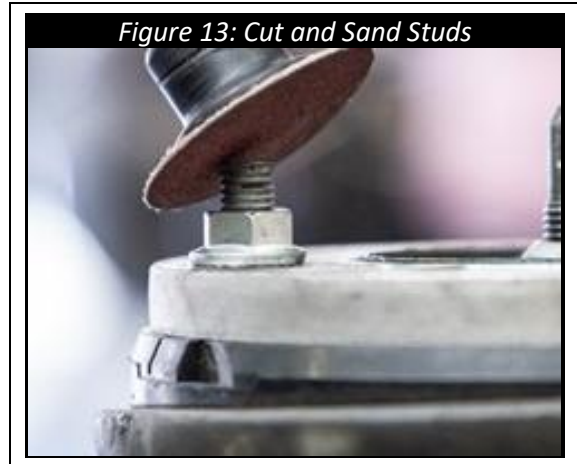
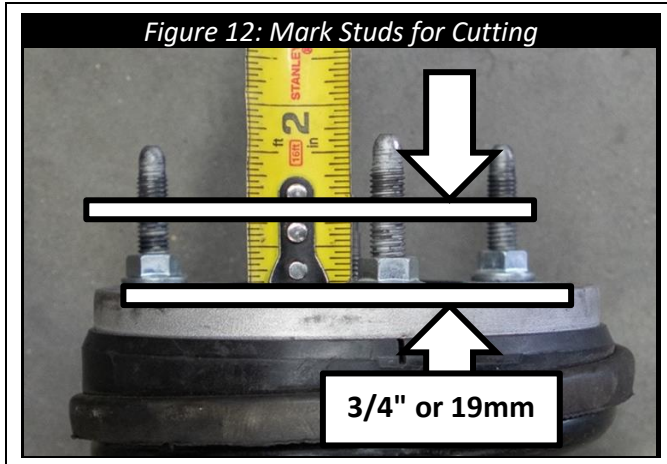

- 14.** Locate 1x **90763**, strut spacer.  
Place the strut spacer on top of the upper strut mount over the studs.  
Install the M10 nuts removed in the prior step, torque to **37 ft-lbs**.
- 15.** Check stud height.  
Place a straightedge on top of the strut spacer and check to make sure all studs are able to pass under the straightedge without disturbing it.  
If needed, sand the tops of the cut studs down until the straightedge can pass over top the studs without be disturbed.

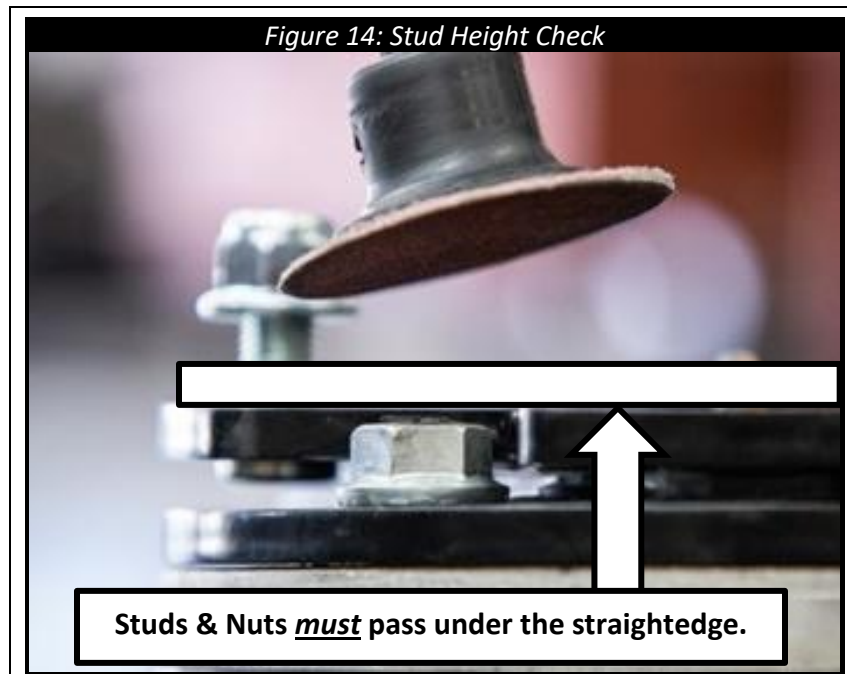

**16. Install strut assembly into vehicle.**

Remove the 3x M10 nyloc nuts from the studs of the strut spacer. Slide the strut assembly into place and install the 3x M10 nyloc nut onto the studs.

Torque hardware to **37 ft-lbs.**

**17. Reinstall lower control arms.**

Locate the mounting bolts removed in a prior step.

Ensure bolts are placed in the position they were removed from.

Torque hardware to **129 ft-lbs.**

- **NOTE:**  
Reinstalling the mounting bolts from where they were removed should get the alignment close enough to be able to drive the vehicle to an alignment shop.

**18. Reinstall lower control arm brace onto the lower control arm.**

Torque hardware to **35 ft-lbs.**

**19. Install the strut onto the lower control arm.**

Locate the mounting hardware removed in a prior step.

Align the lower strut mount with the lower control arm and install the hardware.

Torque hardware to **37 ft-lbs.**

- **NOTE:**  
It may be necessary to push or gently pry the strut into place, this is normal and of no concern.

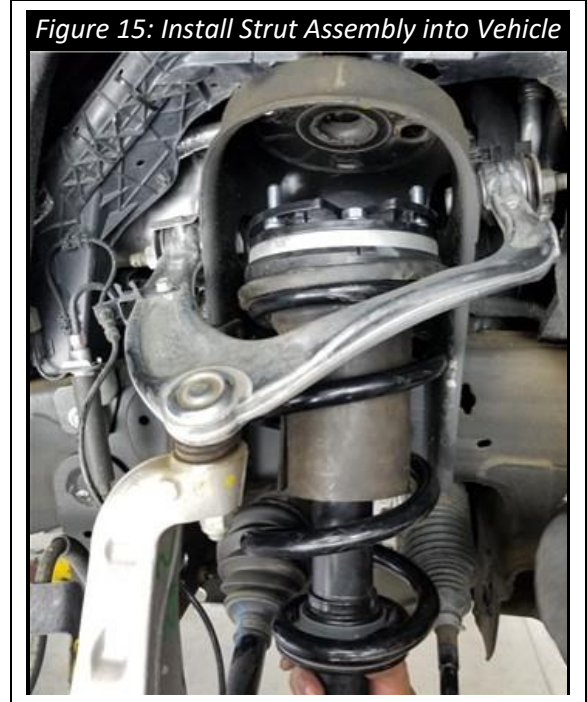



20. On the driver side, remove the wire routing bracket near the top of the spindle.  
Locate the 1x P-clamp in **HP9270**.  
Using the OEM bolt, replace the wire routing bracket with the P-clamp, ensure both wires are restrained by the clamp.  
Torque hardware to **10 ft-lbs**.

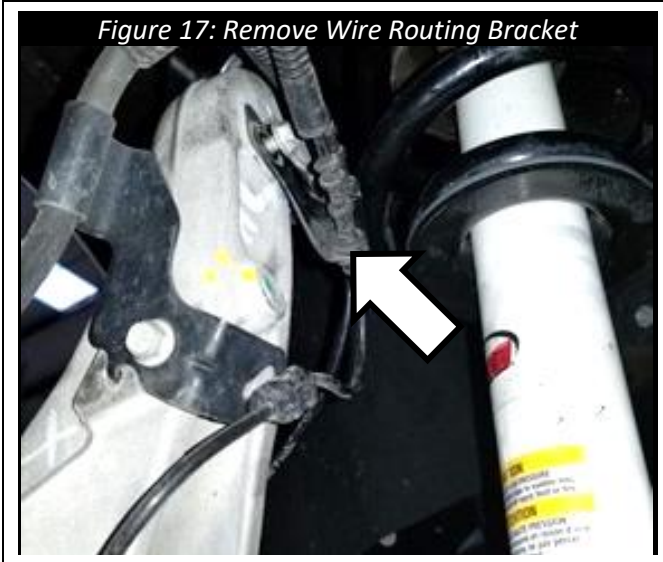

21. Locate the 2x 6" cable ties in **HP9270**.  
Use the cable ties to restrain the wires passing through the P-clamp to the brake line.



22. Moving to the rear of the vehicle, support the rear axle.  
Remove the lower shock mount bolts and set them aside to be reused later.
23. Remove the factory U-bolts and discard them with the nuts.

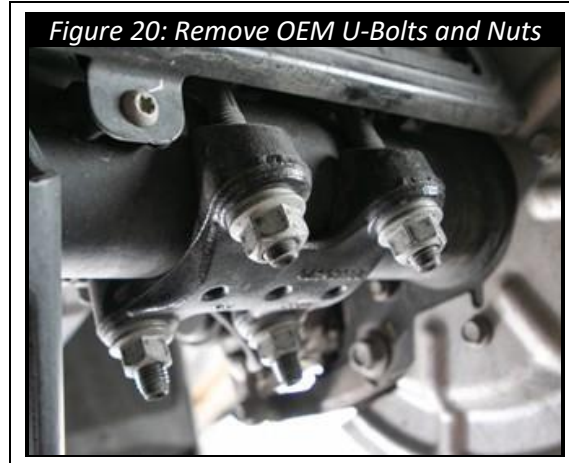

24. Slowly raise the vehicle to separate the axle and leaf springs, keep raising the vehicle until there is enough of a gap between the axle and leaf spring to install the lift block.  
Check to make sure the brake lines will not be overextended when the truck is lifted. Modifications to the OEM brake line brackets might be necessary.

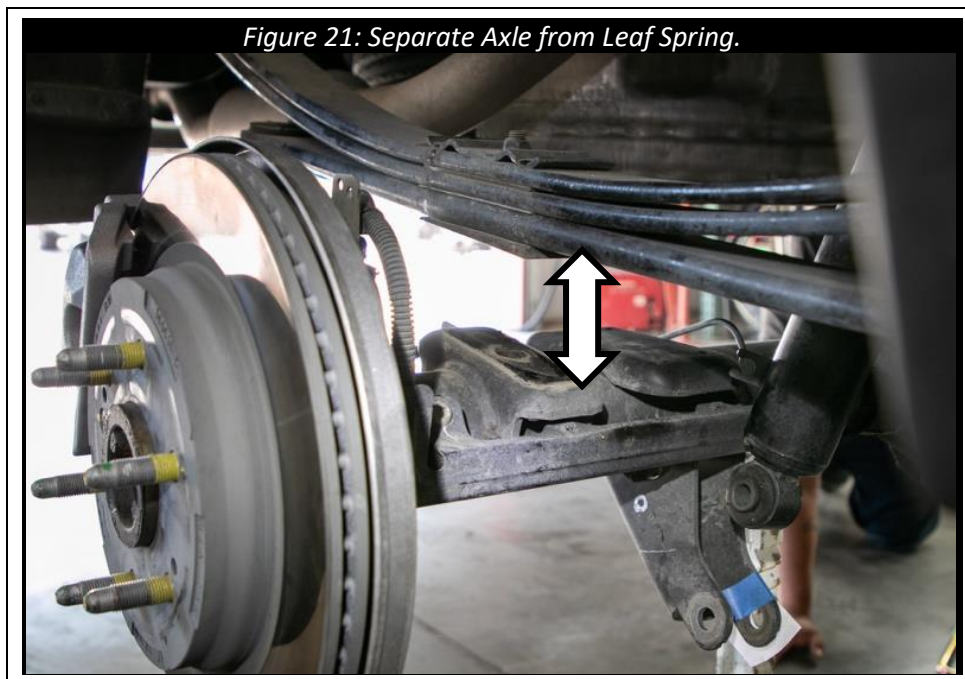

25. Remove the tapered shim on the bottom of the leaf spring pack:  
 Use a c-clamp to hold the leaf pack together.  
 Use vice grips to hold the round head of the leaf spring center pin.  
 Remove the center pin nut, remove the center pin and tapered shim.  
 Reinstall the center pin and nut.  
 Torque the hardware to 30 ft-lbs.

- **NOTE:**  
 All trims except AT4 and Trail Boss have a tapered shim between the axle and leaf spring that must be removed.



26. Locate the 2x **6518**, cast lift blocks.  
 Install the block on top of the axle. The block's center pin should sit inside the hole of the spring perch on the axle.  
 Ensure the center pin of the block is not too long and contacting the axle tube, if needed trim the pin down to eliminate any contact.

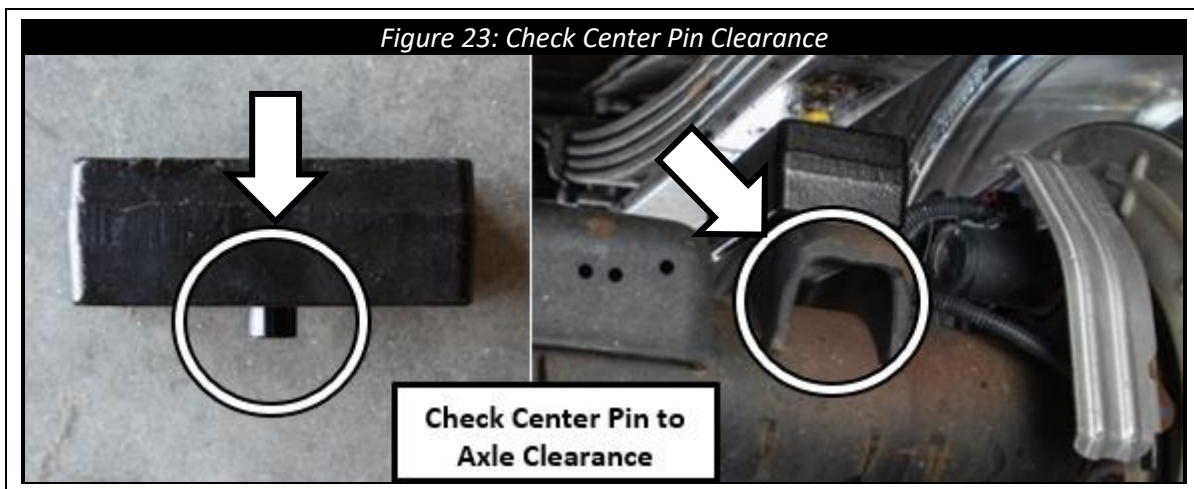

27. Slowly lower the vehicle until the center pin of the leaf spring can engage with the hole in the lift block. Ensure the block and leaf spring center pin are aligned correctly and lower the vehicle until the leaf spring contacts the lift block. Do not lower the vehicle pass this point as this time.



28. Locate the 4x UB-.625X2.6X10.5, extended length U-bolts and re-assemble the U-bolt system with the U-bolt plate on top of the spring pack and the U-bolt lower plate under the rear axle just as they were before disassembly. Apply anti-seize to the threads of the U-bolts before installing the nuts and then install the nuts. Torque to **100 ft-lbs.**, using a star pattern to tighten the nuts evenly.
- **NOTE:**  
The amount of thread protruding from each nut should be about the same.

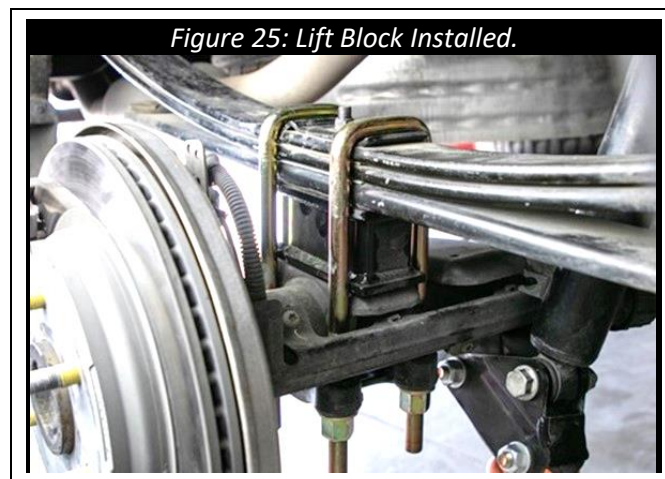

29. Reinstall the lower shock mounting hardware, if needed, compress the shock by hand to install it into the lower mount. Torque hardware to **85 ft-lbs.**
30. Ensure that all bolts are properly torqued. Ensure there are no rubbing or loose cables anywhere after the installation. Use cable ties to restrain any cables from interfering with any other part. Check that all lines are free of stress or interference while the vehicle is in full droop, full bump, and throughout the complete steering cycle.
31. Reinstall wheels and tires.  
Torque lug nuts to OEM specifications.

32. If the only parts installed were from this kit or were OEM then the next few steps can be skipped. (Skip to step #33) Then next steps are to double check the ride height of the vehicle if any aftermarket parts other than what was include in this kit were installed or used.

Before lowering the vehicle, measure from the top of the wheel well directly above the center line of the wheel to the top of the tire. Record this measurement as **A** in Table 1.

Subtract 3 inches from A and record this number as **B** in Table 1.

- **NOTE:**

It can be helpful to place a piece of painter's tape at the top of the wheel well directly above the centerline of the wheel and measure from there.

33. Set the truck on the ground and drive forward and backward a few times to settle the suspension. Measure again from the top of the tire to the top of the wheel well as in the step above and record this measurement as (C) in Table 1.

- **NOTE:**

If (C) is larger than (B), the ride height is too tall. This can be caused by shocks or shock spacers that are too long, stacked shock spacers, spring preload devices, or any combination of the above.

Failure to use compatible shocks to limit the vehicles front suspension may cause over-extension, which as a result can cause damage to ball joints, uni-balls, tie rods, and/or CV axles, along with other related safety issues.

***Warranty on Cognito products will be void if the vehicles front suspension is not properly limited to the above max ride height calculation.***

TABLE #1		
<i>Suspension Travel</i>	<i>ID</i>	<i>Measurement (Inches)</i>
Full Droop	<b>A</b>	
Max Ride Height	$A - 3 = B$	
Current Ride Height	<b>C</b>	

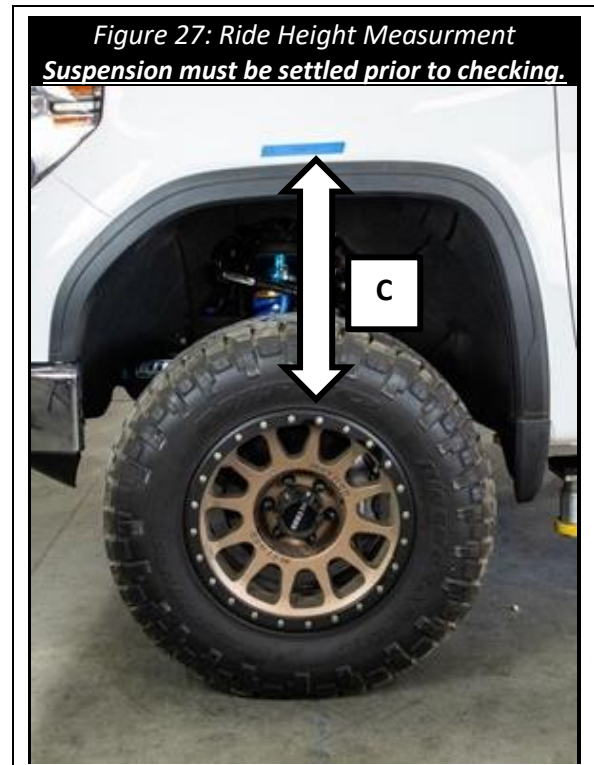
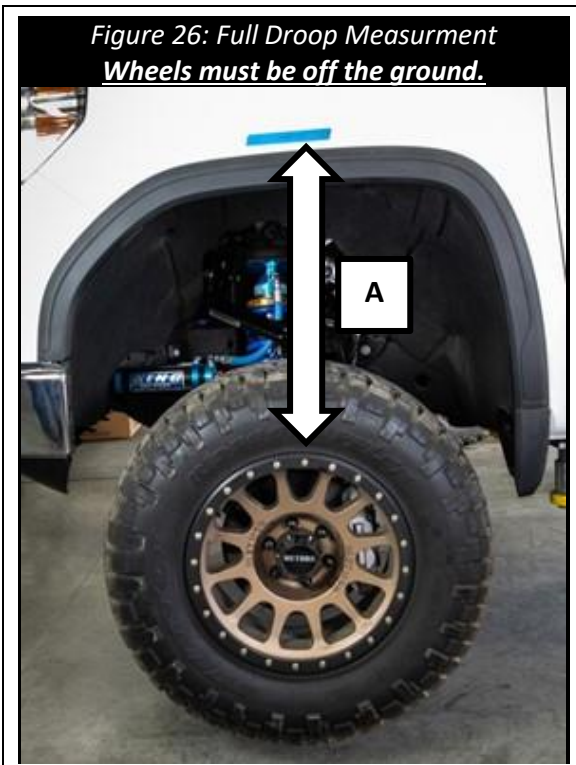

34. Adjust headlights per owner's manual.

35. Have the vehicle professionally aligned.

- **NOTE:**

Cross caster is important in making your vehicle track straight down the road. Most roads have crown to them, high in the middle for water runoff. This crown will make your vehicle want to pull to the right. Vehicles with stock tires on them have a narrow contact patch on the ground and are not as affected as a vehicle having larger wider tires. With larger wider tires it's important to have cross caster proper in order for the vehicle to track straight on these roads. Trucks with dual rear wheels have more tire on the ground and require more cross caster. The length of the wheelbase will also affect cross caster needed.

Generally, crew cab short and long bed trucks like .8 degrees of cross caster. For example, the driver side would have 2° while the passenger side would have 2.8° of caster. Dual rear wheel trucks like .9-1.0 degrees of cross caster. Your area might have roads that are crowned more or less than average therefore these numbers may need to change, and your alignment shop should understand this. If your alignment tech is stating they can't align the truck, that typically means they can't get the alignment to OEM spec, and that's fine because your vehicle is no longer OEM. A good tech will understand this and the numbers and let caster run slightly out of OEM spec (Caster should always be above 2 degrees positive) while maintaining cross caster needed for the vehicle and roads so you enjoy your vehicle with aftermarket Cognito parts and your driving experience. Camber should always be from  $-1^{\circ}$  to  $+1^{\circ}$  and toe should always be .125" to .250" toe in for best tire wear.

***This completes the installation steps, enjoy your new Cognito 2-Inch Economy Leveling Lift Kit!***



## WARRANTY / RETURN POLICY / SAFETY

### **Cognito Limited Lifetime Warranty**

Cognito Motorsports, Inc. hereinafter “Cognito,” warrants to the original retail purchaser, that its suspension products are free from workmanship and material defects for as long as the purchaser owns the vehicle on which the product(s) were originally installed. This warranty will be void if any modifications are made to the components, including alterations to the surface finish, i.e.; painting, powder coating, plating, and/or welding, or if they are improperly installed. Cognito truck suspension products are not designed nor intended to be installed on “competition” vehicles used in race applications, stunt or for exhibition purposes that are outside of the intended operating conditions specified by the manufacturer. Racing and competition are defined as any contests between two or more vehicles; or vehicles competing individually on off road circuits in timed events (whether or not such contests are for an award or prize).

This warranty does not include coverage for police, taxi, government or commercial vehicles, and the warranty does not cover Cognito products sold outside of the USA. Cognito’s obligations under this warranty are specified and applied at its sole discretion, and warranty coverage is limited to repair or replacement of the defective product(s). Any and all costs of removal, installation or reinstallation; freight charges, incidental or consequential damages associated with the covered products are expressly excluded from this warranty.

The following items are exempt from Cognito limited warranty coverage: bushings, bump stops, tie-rod ends (Heim joints) and limiting straps. These parts are “consumables” and designed to wear as a normal part of their duty cycle, therefore they are not considered defective when worn. The aforementioned products are warrantied separately against defects in workmanship, for 60 days from the date of purchase. As a condition of warranty validation, respective Cognito suspension components must be installed as a complete system (not combined with non-Cognito hardware or ancillary parts). Any substitutions or omission of required components will void the warranty. Some minor cosmetic wear and imperfections may occur to parts during shipping, which is not covered under this warranty. This limited warranty does not apply to any components that have been subjected to collision damage, negligence, alteration, abuse, or misuse, and coverage does not extend to products manufactured by third-party companies. Cognito reserves the right to supersede, discontinue, or change the design, finish, part number and/or application of its parts when deemed necessary, without notice.

### **Return Policy**

Product returns will not be accepted without prior written approval from an authorized Cognito representative. All products being returned must be shipped via trackable, prepaid freight. Returned products are subject to a 25% percent restocking fee. The eligible return period for products purchased directly from Cognito is 30 days from the verified date when the product(s) were originally received by the purchaser.

### **Product Safety Advisory**

The installation of Cognito steering and suspension components will modify your vehicle’s original factory equipment and geometry, which may cause it to handle differently than a stock (unaltered) vehicle. Installation of these components is not intended to strengthen nor reinforce the vehicle’s frame, nor are they designed to increase rollover protection. It is necessary to periodically inspect all suspension and drive train components for proper attachment, torque specifications, operation, and for any potential unusual wear or damage. Installation of these parts will modify the height of the vehicle and may raise the center of gravity. Modifying vehicle height combined with off road operation may increase your vehicle’s susceptibility to rollover conditions, which may cause serious injury or death. Many states regulate allowable vehicle height modifications, and it is your responsibility to know and comply with the legal requirements specified by the laws where you reside. Modifications to your vehicle’s ride height may also affect the ride quality, driver input response, trackability and handling, and wear to your vehicle’s suspension components and tires.



This page intentionally left blank.

*Delete this line - Revision table hidden below – ctrl+shift+8 to show*